

K-FLEX® ACCESSORIES



K-FLEX® ACCESSORIES

▶ Complete range of solution for the installers

Site



K-FLEX® GUTTAGENA PVC BAND



Twice the thickness compared to the previous range, it is ideal for finishing PVC sheet insulation coverings (eg. K-FLEX® PACK RS 590). The GUTTAGENA band is available in one colour, light grey, and is matt finished.

MEASUREMENTS

Thicknesses: 0,2 mm
Lengths: 50 m
Widths: 5 - 10 cm

K-FLEX® VINYL BAND



Flexible, robust and resistant to external agents, used for covering pipes insulated with elastomeric insulation or other materials. The small roll sizes allow for applications even in tight and narrow spaces. The wide range of colours available allows for a correct colour-coding of pipes, in compliance with the law.

COLOURS

red
green
blue
grey (K-Pack RS 590 type)
light grey
black

MEASUREMENTS

Thicknesses: 0,1 mm
Lengths: 50 - 25 m
Width: 10 cm



K-FLEX® PVC 200 TYPE W ELBOWS



90° single-piece elbows in laminated plastic. Apart from enhancing the overall appearance of the insulated part, they increase protection against impact.

APPLICATION

After having taken the measurements and having chosen the suitable type of elbow, place it onto the part to be covered. The internal borders should overlap to allow for fastening with the appropriate plastic rivets (see the section "components: fixing products").

MEASUREMENTS

Thicknesses mm: 20, 25, 30, 40, 50, 70, 80, 90
Tube diameters mm: from 17 to 114; inches: from 3/8" to 4".

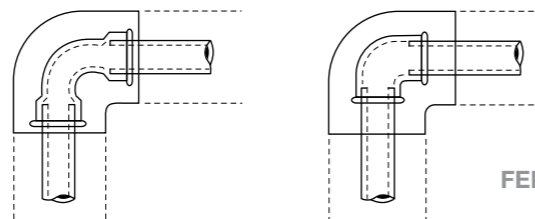

K-FLEX® PACK RS 590



A rigid PVC self-rolling sheet with a smooth grey surface. The sheet adheres perfectly to all cylindrical pre-insulated surfaces. Light and easy to use, this non-drip self-extinguishing product protects the insulation as well as enhancing overall external appearance. To maintain the product features intact, in the winter season the rolls should be stocked at room temperature for 24 hours prior to their use.

USE

It is used as a protective covering and to enhance the external appearance of large and small cylindrical pipes insulated with elastomeric material, glass wool mats, rock wool mats, polyurethane and polystyrene pipe coverings.

APPLICATION

- ▶ Measure and cut a section of the PVC sheet based on the circumference of the insulation, leaving an excess of a few centimeters for overlapping the joining edges.
- ▶ Wrap the sheet around the insulation
- ▶ Seal the borders with plastic rivets (see reference in the section "components: fixing products").

K-FLEX® PACK RS 590 ▶ TECHNICAL DATA	
Property	Value
Base	Rigid PVC
Colour	Standard light grey
Packaging	Rolls
Sheet thickness	0,30 mm ÷ 0,35 mm
Temperature range	from -25 °C to +70 °C
Thermal conductivity λ	0,16 W/(m•K)
Permeability to vapour μ	1,0 gm2 24h Pa

K-FLEX® reserves the right to change data and technical requirements without notice.

K-FLEX® PVC TYPE SE 90° ELBOWS

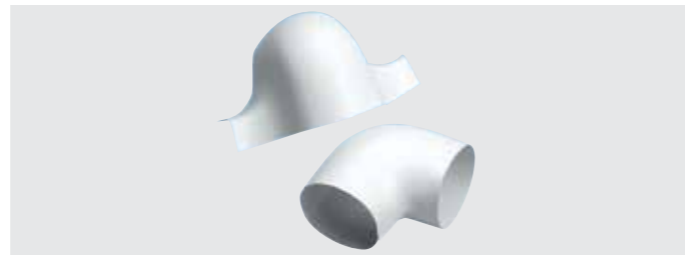

90° single-piece elbows in laminated plastic. Apart from enhancing the overall appearance of the insulated part, they increase protection against impact.

APPLICATION

After having taken the measurements and having chosen the suitable type of elbow, place it onto the part to be covered. The internal borders should overlap to allow for fastening with the appropriate plastic rivets (see the section “components: fixing products”).

MEASUREMENTS

Thicknesses mm: 20, 25, 30, 40, 50, 70, 80, 90
Tube diameters mm: from 17 to 114; inches: from 3/8” to 4”

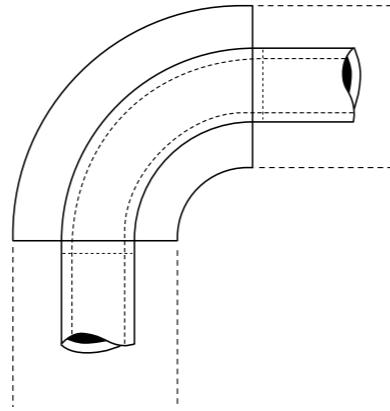

K-FLEX® PVC TYPE T

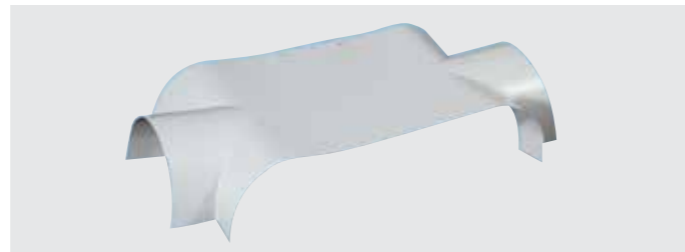

Laminated plastic PVC singlepiece T sections. Ideal for protecting insulated pipes of medium and large diameters.

APPLICATION

The external diameter of the PVC T section also includes the thickness of the insulation.

E.g.: to cover a pipe with a 76 mm Ø (A-B), and a 32 mm thick insulation (C), a 140 x 140 type should be ordered.

MEASUREMENTS

External diameter (main./branch.) mm: from 52/52 to 245/245 from 67/61 to 108/61 from 108/67 to 245/218

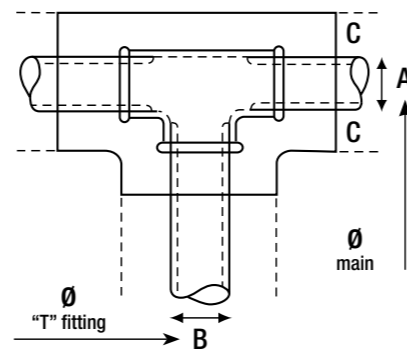

K-FLEX® ALU EMBOSSED R 200

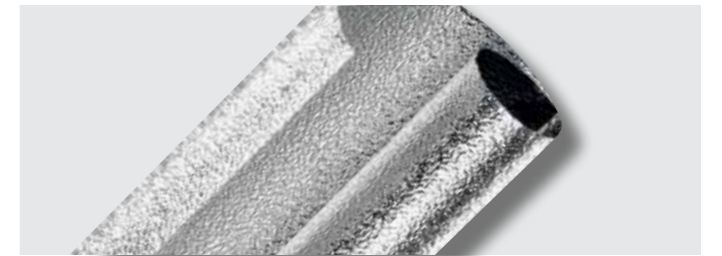

Self-wrapping embossed protection sheet in rolls of 99.5% pure aluminium. Sheet thickness 0.1 and 0.2 mm. Supplied in 1 m wide rolls.

PROPERTIES

The product grips perfectly to all cylindrical pre-insulated surfaces, it is light, easy to handle, protects the insulation and enhances the overall appearance. It is incombustible.

POSSIBILITIES OF USE

Used as a protective covering, it also improves the overall appearance of small and large cylindrical pipes insulated with elastomeric, fibre-glass mattresses, mineral wool, polyurethane and polystyrene.

APPLICATION

If not already pre-cut, cut the sheet to the required circumference. Wrap the sheet around the insulation, seal the longitudinal edges with adhesive foil tape and plastic rivets.

K-FLEX® BLECH MT-CU



99.5% PURE ALUMINIUM SHELL and 90° ELBOWS with a thickness ranging from 0,6 and 0,8. MT 500: male and female ball swaged edges calendered tube, with reinforced length-wise drilled sealing system. Length: 1000mm. CU 501: 90° preformed segmented elbows with female-female ball swaged edges.

APPLICATION ON TUBES

- ▶ The MT 500 tube diameter is slightly greater than that of the corresponding CU 501 elbow, which makes the connection between the two parts much easier.
- ▶ The edges of the joints are fixed together by using the short screws in the holes provided.

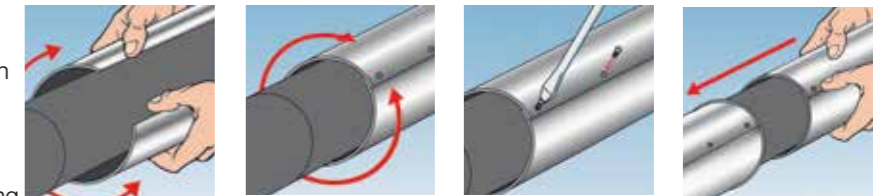

APPLICATION OF CU501 ELBOWS

- ▶ Open the segments of the elbow and place them around the insulated pipe.
- ▶ After the sections have been correctly positioned, seal the elbow with short screws using the holes provided.
- ▶ Connect the MT 500 tube by attaching male edge to female edge.



K-FLEX® ST ANTICONDENSATION TAPE

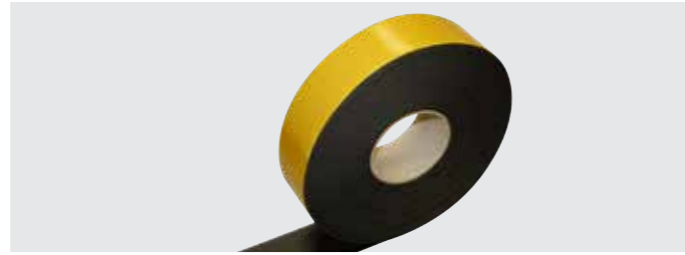

Highly flexible closed cell elastomeric foam (FEF) suitable for hot and cold thermal insulation, featuring a combination of low thermal conductivity, high water vapour diffusion resistance and low flame spread.

MEASUREMENTS

Thickness: 3 mm
Lengths: 10 - 15 m
Heights: 15 - 25 - 30 - 50 - 75 - 100 mm

APPLICATIONS

Pipes, ducts, tanks, applied for refrigeration, air conditioning, heating and plumbing, pipe fittings and water ducts, industrial applications for energy saving and/or condensation prevention purposes.

K-FLEX® ST ANTICONDENSATION TAPE ▸ TECHNICAL DATA											
Property	Value										Test method
Maximum service temperature	+85°C										
Minimum service temperature	-40°C										
Permeability	μ ≥ 7 000										EN 12086
Water absorption	<0.1 %										EN 13472
Leachable chlorides	<500 ppm When tested in line with DIN1988/7, Leachable chlorides <0.05%										EN 13468
Ph	Neutral (7)										EN 13468
Fire rating	Euroclass B- s2, d0										EN 13501
Dimensional tolerances	as for EN14304										
Ecological data	Without CFCs and HCFCs										
Medium temperature	-30°C	-20°C	-10°C	0°C	+10°C	+20°C	+30°C	+40°C	+50°C	+70°C	
Thermal conductivity [W/(m °K)]	0.030	0.031	0.032	0.033	0.034	0.035	0.036	0.037	0.038	0.042	EN12667

K-FLEX® reserves the right to change data and technical requirements without notice.

K-FLEX® SOLAR HT TAPE



Flexible closed cell elastomeric foam (EPDM) suitable for hot thermal insulation, specially designed to suit high temperature applications.

MEASUREMENTS

Thickness: 3 mm
Length: 15 m
Height: 50 mm

APPLICATIONS

Ducts and pipes, specially designed for solar systems and high temperatures.

K-FLEX® SOLAR HT TAPE ▸ TECHNICAL DATA											
Property	Value										Test method
Maximum service temperature	+85°C										
Minimum service temperature	-40°C										
Permeability	NPD										EN 12086
Water absorption	<0.1 %										EN 13472
Leachable chlorides	<500 ppm When tested in line with DIN1988/7, Leachable chlorides <0.05%										EN 13468
Ph	Neutral (7)										EN 13468
Fire rating	Euroclass E										EN 13501
Dimensional tolerances	as for EN14304										
Ecological data	Without CFCs and HCFCs										
Medium temperature	-30°C	-20°C	-10°C	0°C	+10°C	+20°C	+30°C	+40°C	+50°C		
Thermal conductivity [W/(m °K)]	0.037	0.038	0.039	0.040	0.041	0.042	0.043	0.044	0.044	EN12667	

K-FLEX® reserves the right to change data and technical requirements without notice.

K-FLEX® ECO ANTICONDENSATION TAPE

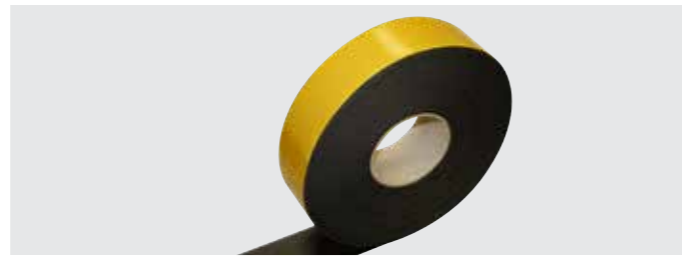

Highly flexible closed cell elastomeric foam (FEF) suitable for hot and cold thermal insulation, free from halogenated flame retarders and halogenated ingredients, featuring a low toxicity in case of fire.

MEASUREMENTS

Thickness: 3 mm
Length: 15 m
Height: 50 mm

APPLICATIONS

Pipes, ducts, tanks, applied for refrigeration, air conditioning, heating and plumbing, pipe fittings and water ducts, industrial applications for energy saving and/or condensation prevention purposes.

K-FLEX® ECO ANTICONDENSATION TAPE ▶ TECHNICAL DATA											
Property	Value										Test method
Maximum service temperature	+85°C										
Minimum service temperature	-40°C										
Permeability	μ ≥ 3 000										EN 12086
Water absorption	<0.1 %										EN 13472
Leachable chlorides	<500 ppm When tested in line with DIN1988/7, Leachable chlorides <0.05%										EN 13468
Ph	Neutral (7)										EN 13468
Fire rating	Euroclass E										EN 13501
Dimensional tolerances	as for EN14304										
Ecological data	Halogen free, PVC, CFC, HCFC e Formaldeide										
Medium temperature	-30°C	-20°C	-10°C	0°C	+10°C	+20°C	+30°C	+40°C	+50°C	+70°C	
Thermal conductivity [W/(m °K)]	0.035	0.036	0.037	0.038	0.039	0.040	0.041	0.042	0.043	0.044	EN12667

K-FLEX® reserves the right to change data and technical requirements without notice.

K-FLEX® COLOR ANTICONDENSATION TAPE



Highly flexible closed cell elastomeric foam (FEF) protected by a layer of specially designed acrylic paint available in different colours.

MEASUREMENTS

Thicknesses: 3 - 6 mm
Lengths: 7,5 - 15 m
Heights: 50 - 100 mm

APPLICATIONS

Pipes, ducts, tanks, applied for air conditioning, heating and plumbing, fittings and accessories.

K-FLEX® COLOR TAPE ▶ TECHNICAL DATA		
UV stability	Value	Test method
Weatherometer	> 2000 Hours	DIN 53231
Desert exposure	> 2 Anni	ASTM G 7-97
Total weight approx.	50 g/m ²	EN 12086
Thickness	45 μ	
Fire rating with K-FLEX® ST	Euroclass C-s3, d0	
Fire rating with K-FLEX® ECO	Euroclass E	
Fire rating with K-FLEX® SOLAR HT	Euroclass E	

K-FLEX® reserves the right to change data and technical requirements without notice.

COLOR RANGE

- RAL 7035 grey - Colour code **G0**
- RAL 9002 white - Colour code **G1**
- RAL 9011 black - Colour code **N0**
- RAL 5012 blue - Colour code **B0**
- RAL 6032 green - Colour code **V0**
- RAL 3000 red - Colour code **R0**

K-FLEX® BITUMINOUS CONGLOMERATE TAPE

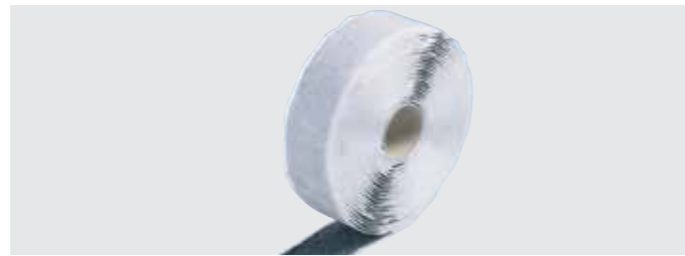

This product was formulated to provide insulation and to prevent condensation on pipes, fittings, and tubings used in heating, air conditioning, refrigeration, and plumbing.

MEASUREMENTS

Thickness: 3 mm
 Lengths: 9 - 15 m
 Height: 50 mm

COMPOSITION

This product is a polymer-based material containing butyl rubber, asphalt, and granulated cork (55% by volume). It contains no fibers.

DETAILS

This product adheres to most clean, dry surfaces and to itself, making it possible to apply more than one layer without adding fasteners or adhesives. It is sufficiently soft and pliable to be molded around most fittings and connections. The material retains its flexibility and adhesion after prolonged exposure to UV and over a service temperature range of -20 °F to 190 °F (-29 °C to 88 °C). It is black in colour and has a grainy, rubber-like consistency.

STORAGE & SHELF LIFE

Indefinite if stored under normal warehouse conditions.

K-FLEX® BITUMINOUS CONGLOMERATE TAPE ▶ TECHNICAL DATA		
Property	Value	Test method
Composition	Select grades of ground virgin cork and synthetic elastomeric materials.	
Colour	Black	ASTM D1729
Odour	Imparts no odor, can be used without danger of contamination.	
Service Temperature	from -30°C to +100°C	
% Solids	>99% by weight	ASTM C771
Specific Weight	0.99 ± 0.05 g/cm ³	ASTM D297
Tensile Yield	2,688 bar	ASTM C907
Elongation to break	>2 inches	TP-019

K-FLEX® reserves the right to change data and technical requirements without notice.

K-FLEX® PVC AT 070 SELF-ADHESIVE TAPE



A thin premium grade plasticized PVC film coated with an aggressive rubber based adhesive with good characteristics. It is highly conformable and unaffected by most chemicals and moisture. Meet ROHS, REACH requirement. It does not contain substances harmful to human body, such as lead and cadmium.

MEASUREMENTS

Length: 25 m
 Heights: 25 - 38 - 50 mm

APPLICATIONS

- ▶ Electric insulation below 600V
- ▶ Insulating wrapping of electric wires and cables
- ▶ Marking of electric wires and cables
- ▶ Can be used indoor and outdoor

K-FLEX® PVC AT 070 SELF-ADHESIVE TAPE ▶ TECHNICAL DATA		
Property	Value	Test method
Total thickness	0.10 mm	ASTM-D-1000
Tensile strength	20 N/cm	ASTM-D-1000
Elongation to break	200%	ASTM-D-1000
Adhesion Strength: to steel to backing	1,5 N/cm 1,5 N/cm	ASTM-D-1000 ASTM-D-1000
Voltage resistance	600 V	UL510
Temperature resistance	80 °C	ASTM-D-1000
Flame resistance	<2 s	ASTM-D-1000
Content of Heavy Metal: Lead, Cadmium Mercury, Chromium Polybrominated biphenyl	<30 ppm <10 ppm <10 ppm	US EPA3052 US EPA3060A US EPA3540C

K-FLEX® reserves the right to change data and technical requirements without notice.

K-FLEX® BUTYL TAPE

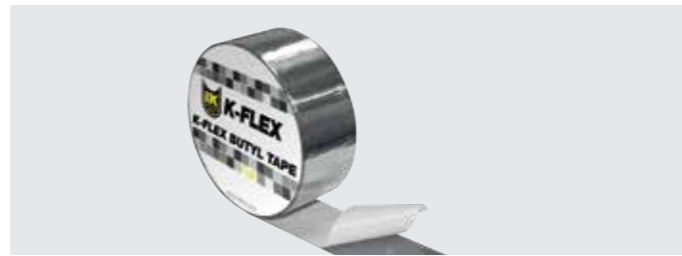

K-FLEX® Butyl Tape is a self-adhesive sealing tape consisting of a high-performance butyl rubber adhesive compound, protected by a reinforced aluminium film. K-FLEX® Butyl Tape is highly adhesive, even at low temperatures, to all common building materials. K-FLEX® Butyl Tape is highly resistant to ageing and UV-rays. K-FLEX® Butyl Tape is available in various sizes for multipurpose applications.

MEASUREMENTS

Length: 10 m

Heights: 50 - 100 mm

FEATURES

- ▶ Tear-resistant
- ▶ Cold applied
- ▶ Excellent adhesion at low temperatures
- ▶ Waterproof and self-sealing
- ▶ Excellent heat stability
- ▶ Resistant to ageing and to UV-rays
- ▶ No oil migration
- ▶ Solvent-free

APPLICATIONS

Choose the most suitable width and metal finish of the sealing tape. Unroll the tape until the desired length is reached. Start removing the release liner that covers the adhesive part of the tape and position the sealing tape. Carry out a rollpressing to avoid entrapment of air bubbles. When connecting two tapes, use an overlap of at least 5 cm. Press with a roller or a cloth pad.

STORAGE & SHELF LIFE

The quality and the characteristics of the materials remain unaltered for a long period of time. However, it is recommended to use the product within 12 months from production date. The product must be stored in the original and unopened packaging in a dry and well ventilated place at a temperature between + 5 °C and + 40 °C. Storage above 50 °C may lead to difficulties in removing the release liner when applying. The product is not affected by frost.

SURFACE PREPARATION

The sealing tape must be applied to a clean, dry, smooth and dust-free surface. For an application between 0 °C and 5 °C, ensure that frost or condensation are absent on the surface. In case of porous supports it's advisable to stabilize the surface. No special tools are required to install this sealing tape.

PRODUCT USE

Sealing and joining materials such as glass, steel, Plexiglas, polycarbonate, wood, aluminium, PVC. K-FLEX® Butyl Tape can be used for the sealing of doors and windows frames, conservatories, gutters, piping and ducting. K-FLEX® Butyl Tape can also be applied in construction on canopies, roofs, chimneys and skylights.

K-FLEX® BUTYL TAPE ▶ TECHNICAL DATA

Property	Value	Test method
Film Type / Colour	Aluminium - PET	
Compound Type / Colour	Butyl Rubber Adhesive / Grey	
Standard Thicknesses	0.6 mm	
Tensile strength	Long. > 150 N / 50 mm Tras. > 150 N / 50 mm	EN 12311-1
Elongation to break	Long. > 20 % Tras. > 20 %	EN 12311-1
Solids	100%	
90° Peel Adhesion	≥ 90 N	ASTM D 1000
Probe Tack	≥ 8.0 N	ASTM D 2979
Vertical Flow	0 mm	ISO 7390
Application Temperature Range	0 °C / + 40 °C	
Service Temperature Range	- 30 °C / + 90 °C	
Test Reports	Flammability Classification: M1, Non-flammable, test by SNPE N°14647-09 (UNE 23727:1990, UNE 23721:1990, NFP 92501). Fire classification: E, test by MPA Stuttgart (EN ISO 11925-2, EN 13501-1). Permeability to Vapour: 1,29 e-16 kg / (m.s.Pa) - μ = 1,53 e+6, test by CSTB CPM 11/260-33839 (NF EN 1931).	

The manufacturer disclaims all liability for product use and applications. Butyl sealants are plastic products. They possess no elastic recovery. Do not use for permanent fixing or in load bearing applications instead of an adhesive or a mechanical fixing. Butyl adhesive are sensitive to solvents. It is advisable to check the chemical compatibility of the butyl adhesive with the substrate adhesives.

K-FLEX® reserves the right to change data and technical requirements without notice.

K-FLEX® PE INSULATION TRIMMING

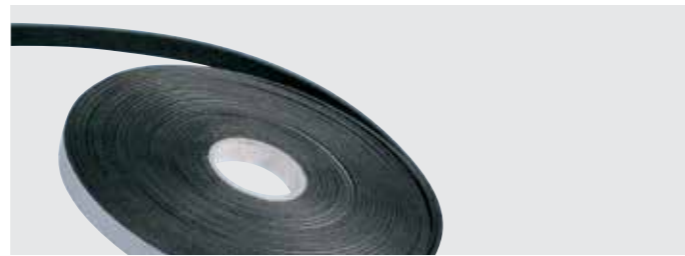

Self-adhesive closed cell reticulated PE foam tape, used to cover the seal flange in air-conditioning ducts.

MEASUREMENTS

Thicknesses mm: 3
Length m: 20
Height mm: 15, 20, 25

K-FLEX® ADHESIVE DISPENSER



A useful accessory that controls flow and helps spread adhesives evenly on insulation surfaces, avoiding having to continuously dip the brush into the tin of adhesive. The adhesive correctly diluted, is manually pumped through the brush.

SPECIAL THINNER FOR K-FLEX® ADHESIVES



Before covering the surfaces to be insulated, it is advisable to clean them with the special K-FLEX® thinners which, thanks to its composition, is also suitable for use with K 414, K 420 or K 425 adhesives. Cleaning of all surfaces with the special K-FLEX® thinners also improves the performance of the adhesives. The special K-FLEX® thinners can be also used for cleaning brushes and spatulas used to spread the glue. Available in 1 litre tins.

K-FLEX® FASTENING PRODUCTS PLASTIC RIVETS, PUNCH AND K-FIX

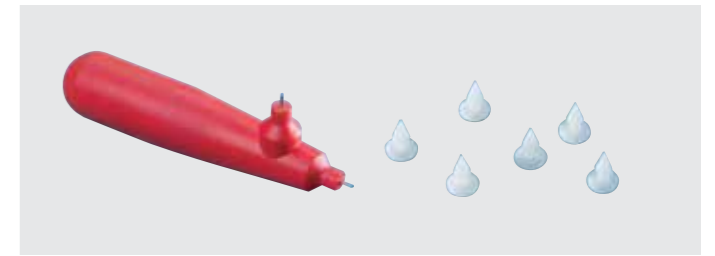

Important for correctly fastening PVC and AL CLAD sheets.
PLASTIC RIVETS: box of 100 WHITE and GREY rivets.
PUNCH: straight/angular

K-FIX. Galvanized steel installation hangar spike with a 50x50 mm base. With adhesive and nonadhesive surface, with a 2,7 mm diameter stick pike, and a self-blocking 30 mm diameter disc.

It can be applied to flat metal surfaces for fastening insulation material in sheet or roll form (mineral wool, polyethylene, etc.). Strongly recommended for air-conditioning ducts.

TEMPERATURE RANGE

min/max +10 °C/ +80 °C.
Supplied in boxes of 100 pieces.
Length of pins - from 19 to 114 mm.

APPLICATIONS

- ▶ Punch holes along the overlap of the sheet, going through both layers.
- ▶ Insert the plastic rivets in the holes, pressing them firmly into the insulation layer.

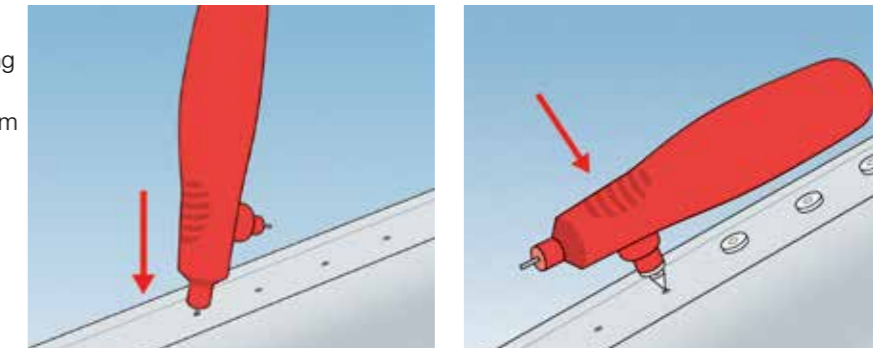

INSTRUCTIONS FOR THE USE OF K-FIX SELF-ADHESIVE SUPPORTS NO. OF PIECES REQUIRED PER M ² AND NO. OF SUPPORTS REQUIRED														
TYPE A: HORIZONTAL USE TYPE B: VERTICAL USE	INSULATION THICKNESS													
	20 MM		25/30 MM		35/40 MM		50 MM		60 MM		80 MM		100 MM	
	TYPE A	TYPE B	TYPE A	TYPE B	TYPE A	TYPE B	TYPE A	TYPE B	TYPE A	TYPE B	TYPE A	TYPE B	TYPE A	TYPE B
20 kg/m ³	8	4	8	4	8	4	8	4	8	4	8	4	10	6
30 kg/m ³	8	4	8	4	8	4	8	4	10	6	10	6	10	6
40 kg/m ³	8	4	8	4	8	4	10	6	10	6	10	6	12	8
50 kg/m ³	8	4	8	4	10	6	10	6	10	6	12	8	14	10
80 kg/m ³	8	4	10	6	10	6	12	8	12	8	14	10	16	12
100 kg/m ³	10	6	10	6	12	8	14	10	14	10	16	12	20	16

K-FLEX® ADHESIVE



K-FLEX® K 414, K 420 and K 425 glues have been specifically designed for use with K-FLEX® elastomeric foam insulation material. The securely bonded surfaces and joints are resistant to ageing and atmospheric agents, and preserve the technical characteristics of the insulating material.

K 414 ADHESIVE in tins of: 0.5 - 0,8 - 2.6 litres

K 420 ADHESIVE in tins of: 0.25 - 1 - 2.6 litres

K 425 ADHESIVE in tins of: 0.85 litre (complete with glue activator)

INDICATED CONSUMPTION OF 1 LITRE OF ADHESIVE		
▼ Tubes ▼	▼ Glued to the heads ▼	▼ Glued lengthways ▼
Thickness 9 mm	every 1350 m	every 150 m
Thickness 13 mm	every 500 m	every 100 m
Thickness 19 mm	every 300 m	every 80 m
Thickness 25 mm	every 220 m	every 60 m
Thickness 32 mm	every 180 m	every 40 m
Thickness 40 mm	every 139 m	every 27 m

Sheet: 1 litres every 7m2
K-FLEX® does not accept responsibility for different values to those indicated.

K-FLEX® K-FINISH PAINT



K-FINISH is a water-based paint for coverings on internal and external installations insulated with K-FLEX® materials. With its polymerized acrylic base, it does not pollute and does not give off odours, and is particularly recommended for all indoor uses. Quick drying, it offers excellent protection. Coats of white paint, applied over a layer of K-FINISH will maintain their colour even in dark environments. The colours are resistant to light. It is advisable to paint the surface of externally insulated pipes to protect them against harsh weather conditions and UV rays. For further protection it is advisable use a double layer of K-FINISH paint. Available in 2.5 litre tins, and on request, in various colours.

K-FLEX® COLOR PAINT



Special paint for retouching the surfaces of COLOR coverings, scratched or damaged during installation. The paint, ready for use, should be applied with a soft brush.

Available in 0.5 litre tins.

COLOR RANGE

- RAL 7035 grey
- RAL 9002 white
- RAL 9011 black
- RAL 5012 blue
- RAL 6032 green
- RAL 3000 red

K-FLEX® ALUMINIUM ENDCAPPING IN ROLLS

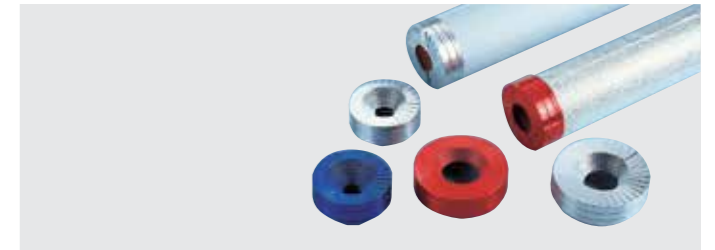

Special endcapping in ribbed aluminium for sealing the ends of insulated pipes. Available in the following colours: SILVER, LIGHT GREY, BLACK, BLUE and RED. Length of rolls - 10 m.

The different colours make it easier to identify the various pipes of a system.

MEASUREMENT

18x32, 23x32, 28x32, 38x42, 48x42, 58x42 mm

APPLICATION

- ▶ Place a cap of insulating material over the end of the pipe
- ▶ Cut a strip of the endcapping long enough to wrap around the circumference of the pipe covering
- ▶ Wrap the endcapping around the end of the insulated pipe and around the edges of the pipe covering
- ▶ Fix the endcapping to the pipe covering with the correct selfadhesive tape

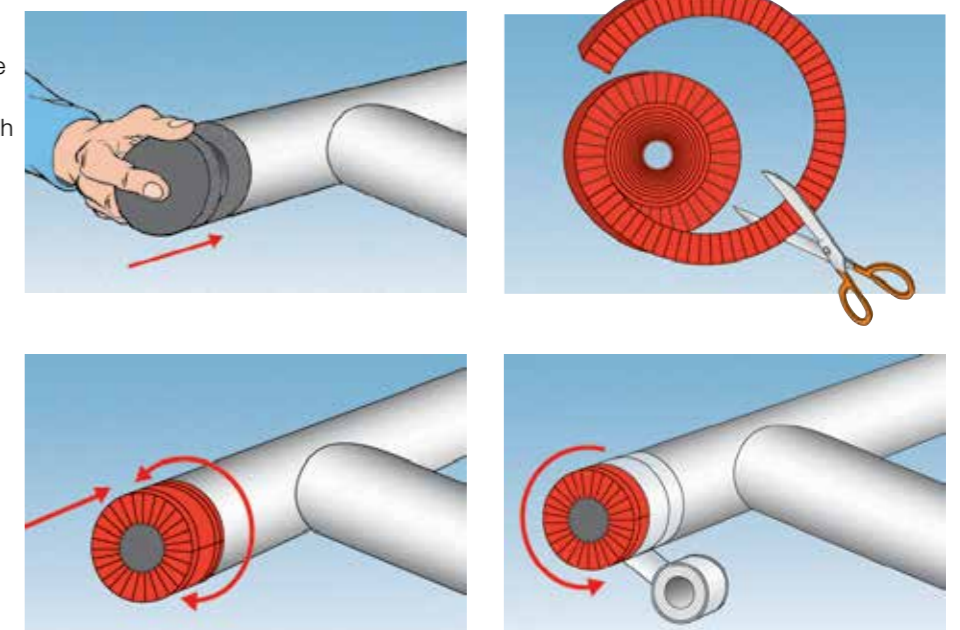

NEW FOR THE INSTALLER: K-FLEX® TOOLBOX!

K-FLEX® is pleased to introduce to its accessory range tool sets specifically tailored to each type of installation.

After extensive research, the K-FLEX® team has selected the best tools to support measurement, cutting and gluing ...everything necessary for the application of our insulating products!

▶ **MEASURING TOOLS:**

In addition to the classic metal rolling meter and the wooden meter we have also selected a sturdy metal rule to facilitate linear cuts, a caliper and a compass suitable also for large diameter pipes and a cut-resistant template for the measurement and creation of elbows and T's.

▶ **CUTTING TOOLS:**

In addition to the classic cutter with spare blades, we offer a set of knives of varying lengths complete with sharpening stone, a large mitrebox with grooves at 45°, 22.5° and 90° to facilitate the sectioning of the tube and a set of copper cores of various diameters to make the necessary holes to isolate valves, etc. All cutting tools are supplied with the correct blade guard or packaging specifically designed for transport, protection of the installer and of the product itself.

▶ **GLUING TOOLS:**

We offer a K-FLEX® glue package specifically designed for our products to be used in conjunction with a set of flat brushes of different sizes or with the appropriate K-FLEX® applicator, as recommended in our installation manuals. There is also a special solvent-resistant container for cleaning brushes. In the toolbox you will find everything necessary for tracing onto our insulation products, a K-FLEX® installation manual and innovative multi-purpose wipes for cleaning hands and tools, without using water. All our solutions, designed for the installer, are divided into practical sets for each installation: BASIC, MEDIUM and PREMIUM SET.

K-FLEX® TOOLBOX BASIC SET

- ▶ K-FLEX® Knife case
- ▶ 3 Knives
- ▶ Sharpening stone
- ▶ Cutter + Spare blades
- ▶ Cutting template



K-FLEX® TOOLBOX MEDIUM SET

- ▶ K-FLEX® Bag
- ▶ K-FLEX® Knife case
- ▶ 3 Knives
- ▶ Sharpening stone
- ▶ Cutter + Spare blades
- ▶ Cutting template
- ▶ Mitre box
- ▶ Caliper
- ▶ Compass
- ▶ 2 Brushes
- ▶ Yellow marker
- ▶ Tape measure
- ▶ Metal ruler
- ▶ Nail punch



K-FLEX® TOOL BOX BASIC SET



K-FLEX® ACCESSORIES ▶ TOOL BOX - BASIC SET		
Description	Dimension	Code
<p>KNIVES 3 K-FLEX® knives with stainless steel blades chrome molybdenum vanadium: 1 knife with 10 cm blade, 1 knife with 20 cm blade and 1 knife with 36 cm blade. Semi rigid and anti-slip plastic handle, with blade guard.</p> <p>CUTTER + SPARE BLADES 18 mm K-FLEX® Cutter + 1 box containing 10 spare blades.</p> <p>SHARPENING STONE Oval shaped tapered sharpening stone.</p> <p>CUTTING TEMPLATE K-FLEX® A4 PVC cutting template 1 mm thick., 21x29,7cm.</p>	53x27x7cm	850VRMK0001

K-FLEX® TOOL BOX MEDIUM SET



K-FLEX® ACCESSORIES ▶ TOOL BOX - MEDIUM SET		
Description	Dimension	Code
<p>KNIVES 3 K-FLEX® knives with stainless steel blades chrome molybdenum vanadium: 1 knife with 10 cm blade, 1 knife with 20 cm blade and 1 knife with 36 cm blade. Semi rigid and anti-slip plastic handle, with blade guard.</p> <p>CUTTER + SPARE BLADES 18 mm K-FLEX® Cutter + 1 box containing 10 spare blades.</p> <p>SHARPENING STONE Oval shaped tapered sharpening stone.</p> <p>CUTTING TEMPLATE K-FLEX® A4 PVC cutting template 1 mm thick., 21x29,7cm.</p> <p>MITRE BOX Stanley/K-FLEX® ABS Mitrebox, 230mm long x 95mm wide.</p> <p>BRUSHES 2 K-FLEX® brushes with yellow plastic handle, 3 cm and 7 cm wide</p> <p>METAL RULER and TAPE MEASURE K-FLEX® ABS 3m tape measure with imperial and metric measurements. K-FLEX® 30cm aluminium ruler.</p> <p>CALIPER and COMPASS K-FLEX® 300mm outside metal caliper for measuring the external size. K-FLEX® carpenter's compass with a metal arc and binding screw for setting at the desired degree of opening</p> <p>YELLOW MARKER Marker Edding/K-FLEX®: waterproof yellow marker pen, quick-drying, low-odour, lightfast and durable.</p> <p>NAIL PUNCH K-FLEX® nail punch, straight/angular for the accurate fastening of PVC and K-FLEX® AL CLAD foil.</p>	62x30x25cm	850VRMK0002

For stock availability, consult the relevant sales office.